



sirius
Buying Group

THE KITCHEN COLLECTION 2023/2024

creating your kitchen

Welcome to The Kitchen Collection, a selection of affordable stylish kitchens designed and made in Britain.

So, you are embarking on an exciting journey to create your new kitchen, congratulations! Located at the heart of the home the kitchen is increasingly in popularity as an open plan space that combines dining and living areas. It's a space that you can socialise and entertain in, so we'd love to help you pick a style that you are sure to want to show off.

All our kitchens are FSC® certified assuring you that the wood comes from well managed forests and FIRA Gold certified which is the mark of furniture excellence.

The Kitchen Collection brings together a wide selection of kitchen ideas and styles, giving you a designer kitchen that you will be delighted with. Once you've got an idea on the kitchen colours, theme, style and layout you like then it's time to spend some time with your kitchen designer.



NEW ENGLAND	06-09
WATERFORD	10-13
WEXFORD	14-15
AUSTIN	16-17
PRINCETON	18-23
LANGDALE	24-25
ASHBOURNE	26-27
CRANBROOK	28-29
HARVARD	30-33
CLASSIC DOOR OPTIONS	34-35
CLASSIC HANDLE OPTIONS	36-37



CLASSIC

austin midnight blue



CONTEMPORARY

turin hunter green

40-43	NEW YORK
44-47	ALTA
48-49	WOODBURY
50-53	URBAN
58-61	MELROSE
62-63	HACIENDA
64-65	PLAZA
66-67	VIRGINIA
68-69	CONTEMPORARY DOOR OPTIONS
70-71	CONTEMPORARY HANDLE OPTIONS

74-75	LINEAR AVANT
76-77	LINEAR TREND
78-79	LINEAR FINESSE
80-83	LINEAR ICON
84-85	LINEAR ICE
86-89	LINEAR FORM
90-91	HANDLELESS DOOR OPTIONS



HANDLELESS



FINISHING TOUCHES

marble bianco 22mm worktop

94-97	WORK SURFACES
98-99	SPLASHBACKS
100-103	DRAWER SOLUTIONS
104-105	STORAGE SOLUTIONS
106-107	LIGHTING & ACCESSORIES

CABINET SPECIFICATION	108-113	SPECIFICATION
-----------------------	---------	---------------

YOUR CLASSIC STYLE

This range of kitchens exudes warmth and character to form a wonderful welcoming feel. From classic smooth shaker doors in subtle tones, to our painted ash veneered options available in several on-trend colours; you can create a country cottage style or a more sophisticated modern kitchen design.

All of our kitchen ranges can be styled to look more traditional or to take a modern twist on a classic design.

The handle choice and the work surface make a big impact on the overall style.

The choice of colour is also influential with a traditional look being created by using colours such as Hunter Green, Sage and Stone, complemented with an Oak work surface and aged brass handles. For a more modern look use black, deep blue or green tones for frontals or be a bit more bold and choose our new Carmine Red colour.

classic providence blue grained shaker design



traditional style



finishing touches

Create your unique style when selecting handles, work surfaces and wall splashbacks.

exquisite carmine red and harbour grey smooth shaker door

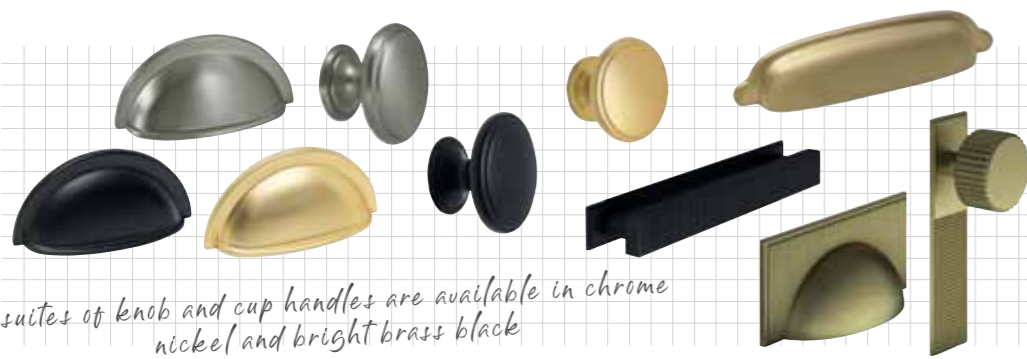

suites of knob and cup handles are available in chrome nickel and bright brass black

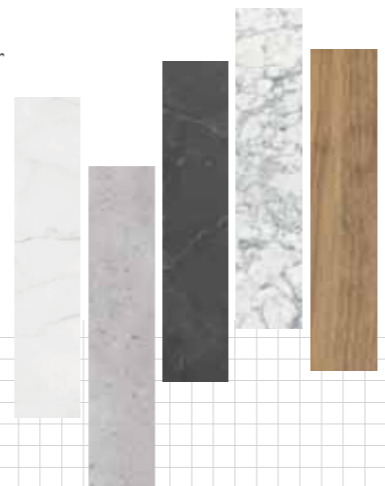

timber, marble or stone design work surfaces work well with classic kitchens



on trend paint to order colours

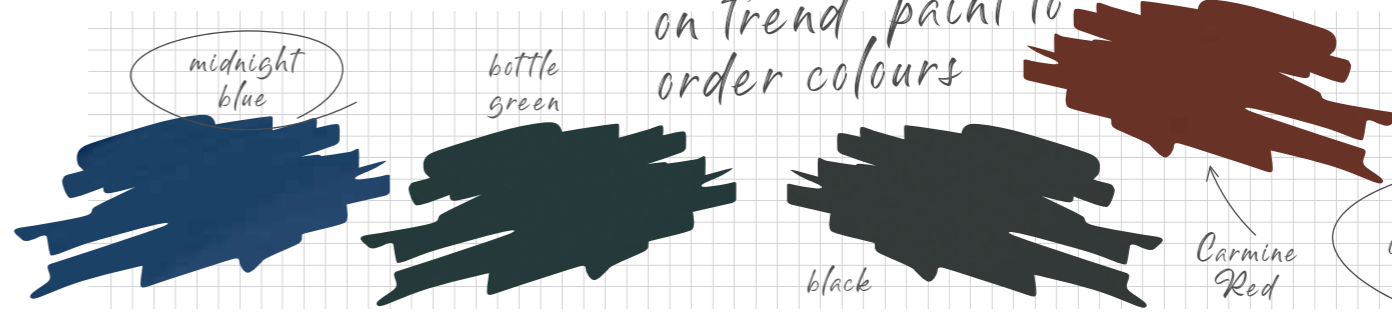

mix with our riviera oak cabinet or frontals for a dramatic yet mellow look



6

NEW ENGLAND PAINT TO ORDER

The traditional British country-house feel is represented in our New England Paint to Order range. The veneered timber shaker style doors and drawers open from a framed cabinet. Your ideal style can be achieved with our full palette of paint to order colours and a collection of classic or modern handles.

PRICE BAND - 6

traditional in-frame design

NEW ENGLAND CHALK WHITE AND CARMINE RED
NERO ASSOLUTO GRANITE WORK SURFACE
MATT BLACK CUP AND KNOB HANDLES (HPK813, HPK814)



NEW ENGLAND MIDNIGHT BLUE AND PEARL GREY

cararra marble work surface

vintage nickel pewter bar handle

get the look

midnight blue and pearl grey finishes

← riviera open cabinets with black frame

↑ chalk white mantle shelf and corbels

WATERFORD PAINT TO ORDER

Charming, pretty and beautifully versatile, Waterford Paint to Order is a painted ash veneered shaker kitchen. It features intricate beading around the shaker frame that gives the design its classic style. Pick a paint colour to suit your home such as black with our black cup and knob handles.

PRICE BAND - 5

charming beaded shaker

WATERFORD BLACK
SOLID TIMBER WORK SURFACE
MATT BLACK CUP AND KNOB HANDLES
(HPK813, HPK814)



12

WATERFORD BLACK PAINT TO ORDER WITH RIVIERA FEATURE
CABINETS SOLID TIMBER WORK SURFACE
MATT BLACK CUP AND KNOB HANDLES (HPK813, HPK814)



13

*elegant freestanding dresser unit
created from stacked wall cabinets
with open storage area underneath*

WEXFORD PAINT TO ORDER

The raised centre panel shaker style of Wexford Paint to Order lends itself to a refined kitchen design. Available in our full palette of painted colours, accessorise with co-ordinating cornice, pelmet, table legs and statement handles to create a classic masterpiece.

PRICE BAND - 5

on trend aged brass handles

traditional table legs

classic refined design

WEXFORD BOTTLE GREEN
CARRARA MARBLE WORK SURFACE
AGED BRASS EFFECT KNOB AND CUP
HANDLES (HPK880, HPK881)

traditional mantle

glazed wall cabinet with contrasting riviera interior

AUSTIN PAINT TO ORDER

Inspired by the classic beauty of simple shaker design, Austin is an undeniably elegant kitchen. The painted veneered timber style is a timeless creation that will never go out of fashion. Austin Paint to Order is available in our full suite of paint colours.

PRICE BAND - 5

classic simple shaker

AUSTIN MIDNIGHT BLUE
SILESTONE GOLD CALCUTTA AND SOLID TIMBER
OAK WITH GREY STAIN WORK SURFACE
SATIN NICKEL CUP HANDLE (HPK847)
& SATIN NICKEL KNOB (HPK848)

18

→
painted pearl
grey open plate
rack cabinets

→
modern
chrome
handles

→
additional storage
cabinets

a modern classic

PRINCETON

This classic and simple smooth one piece shaker door allows you to create a traditional or contemporary look in your kitchen. With four standard colour options and a Paint to Order option in our full painted colour palette, you can add your own touches of style.

PRINCETON PRICE BAND - 3
PRINCETON PAINT TO ORDER
PRICE BAND - 4

PRINCETON INDIGO AND PEARL GREY
LYRA SILESTONE WORK SURFACE
CHROME CUP AND KNOB HANDLES
(HPK815, HPK816)

20



PRINCETON PROVIDENCE BLUE AND CHALK WHITE
 EARTHSTONE ONDA WORK SURFACE
 BARRINGTON MATT BLACK KNOB & PULL HANDLES (HPK875, HPK877)

21



get the look

earthstone onda work surface

black knob and pull handles with backplate

chalk white

providence blue

22

23

PRINCETON PAINT TO ORDER CARMINE RED & HARBOUR GREY
20MM SILESTONE DESERT SILVER WORK SURFACE
MATT BLACK CUP HANDLE (HPK813) & MATT BLACK KNOB (HPK814)

boot room drawer cabinets

simple shaker design

LANGDALE

With its subtle grain texture and thin shaker frame Langdale is the perfect addition to any home. Whether you want a traditional look or a more modern design this range has everything you need. Langdale is available in three stunning colour options; Fern Green, Indigo and Providence Blue.

LANGDALE PRICE BAND - 2

LANGDALE FERN GREEN
20MM SILESTONE CALCUTTA GOLD
WORK SURFACE
MATT BRASS CUP HANDLE (HPK908)
& MATT BRASS KNOB (HPK909)



detailed classic design

tea tray cabinet

ASHBOURNE

This exquisite grained shaker design features a chamfered frame and is available in a standard Ivory finish, as well as our full palette of paint to order colours, including the on-trend deep indigo shown here. Choose brass or copper handles to create a sophisticated kitchen to suit your home design.

ASHBOURNE IVORY PRICE BAND - 2
ASHBOURNE PAINT TO ORDER
PRICE BAND - 3

ASHBOURNE INDIGO
SOLID TIMBER AND WHITE QUARTZ
WORK SURFACES
TRADITIONAL ANTIQUE COPPER KNOB & D
HANDLES (HPK784, HPK785)

plenty of storage in
our diagonal larder

28

CRANBROOK

The smooth Cranbrook kitchen is a stylish take on a timeless five-piece shaker design. Available in Cobble Grey, Platinum, Sage and Stone, it offers a palette that can be accentuated with statement handles, work surfaces and flooring.

PRICE BAND - 2

convenient
wine rack

smooth classic style

CRANBROOK COBBLE GREY AND PLATINUM
LYRA SILESTONE WORK SURFACE
TRADITIONAL ANTIQUE COPPER KNOB &
D HANDLES (HPK784, HPK785)



pantry cabinets for generous storage

rose gold bar handles to add a modern twist

30

smooth shaker style

HARVARD

The simple shaker design of Harvard is available in the on-trend colours Charcoal, Hunter Green and Pebble. With an anti-fingerprint robust surface and its narrow frame detail this smooth one piece shaker style kitchen is the picture of elegance.

PRICE BAND - 1

HARVARD HUNTER GREEN
EARTHSTONE NEVE WORK SURFACE
PAROL ROSE GOLD D HANDLE (HPK869)



HARVARD PEBBLE
40MM CARBON STEEL WORK SURFACE
PAROL MATT BLACK D HANDLE (HPK868)



hunter green

get the look

parol rose gold handle



new work surfaces



The dark and moody tones of Harvard Hunter Green create a sophisticated look which works well with a rose gold handle. Use a light coloured work surface to give this shaker kitchen a more modern look.

CLASSIC DOOR SUITE

Now you have seen the selection of kitchen styles we offer it's time to shortlist your favourites. Do you want a single colour kitchen or will you mix and match different decors?

Our paint to order ranges are available in any of the 22 paints shown, whilst all the available colours of our general kitchen ranges are shown below. Then browse the handle and work surface pages to collate your preferred style.

PAINT TO ORDER DOOR STYLES



PAINT TO ORDER COLOURS



CLASSIC

STAMFORD



Character Oak



Stamford Glazed (Textured Clear Glass)

PRINCETON



Indigo



Pearl Grey



Chalk White



Providence Blue

ASHBOURNE

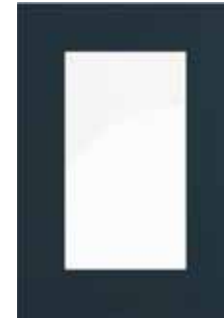

Princeton Glazed (Clear Glass)



Ivory



Ashbourne Glazed (Clear Glass)

LANGDALE



Fern Green



Indigo



Providence Blue

CRANBROOK



Langdale Glazed (Clear Glass)



Platinum



Cobble Grey



Sage



Stone



Cranbrook Glazed (Clear Glass)

HARVARD



Charcoal



Hunter Green



Pebble



Door and draw fronts in this range are made using rPET foil made from recycled plastic bottles

CLASSIC HANDLES

Our wide selection of handles to suit Classic kitchens include cup and knob sets as well as a range of shapes and styles. There is a suite of finishes including black, brass, chrome, copper and pewter to create a unique look and feel that is personal to you.

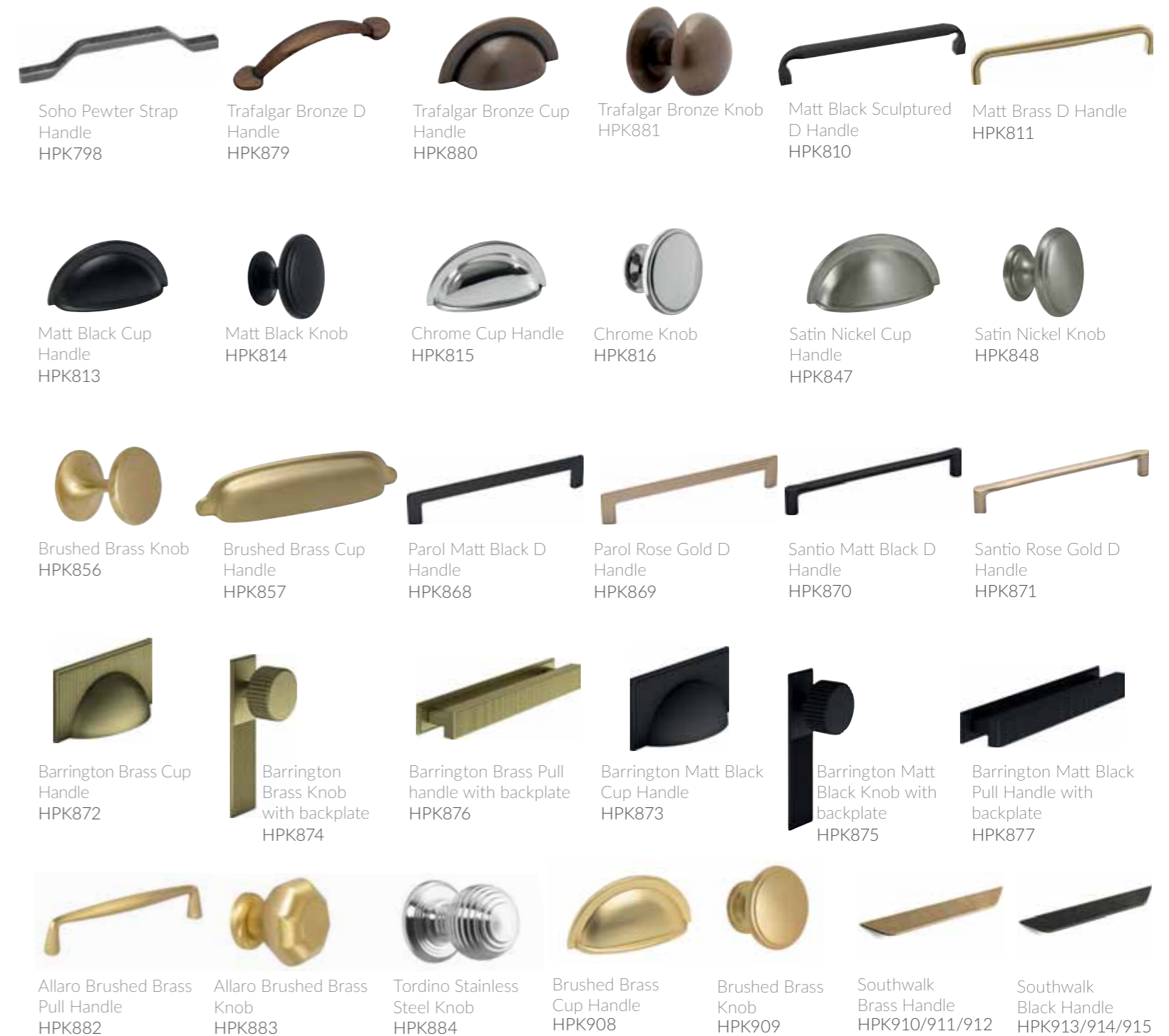
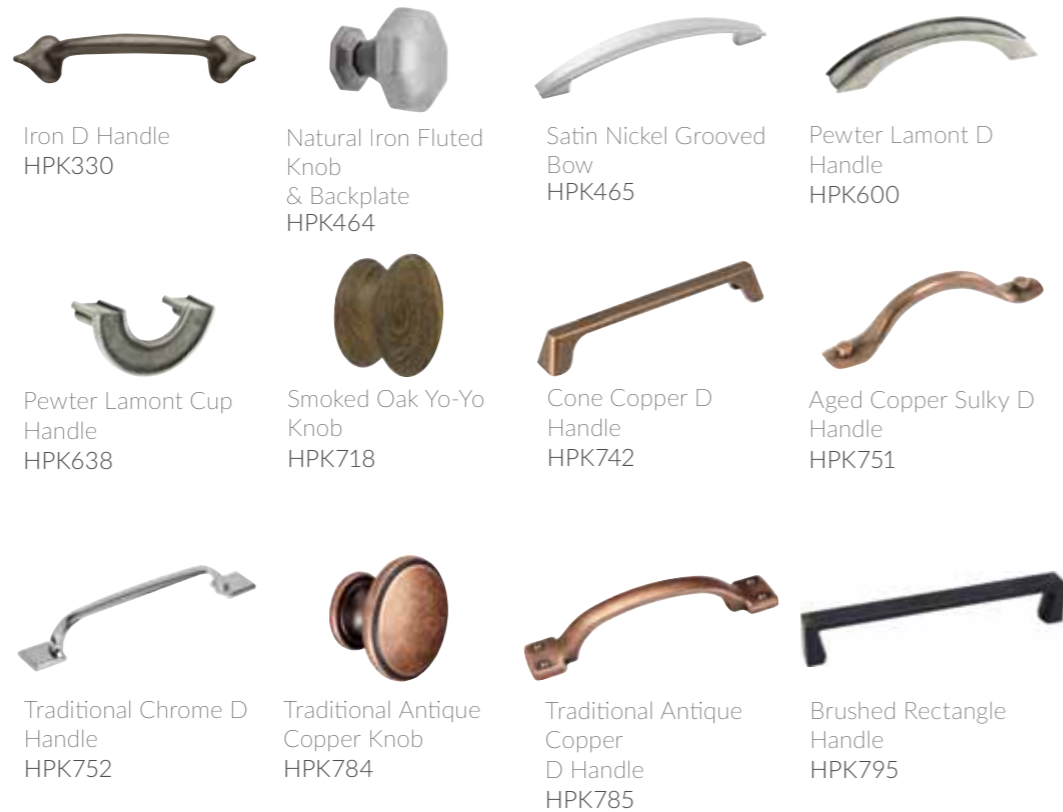

INLINE HANDLES

Our Inline trims offer a contemporary sleek style kitchen design that creates a handleless look and accentuates clean flowing horizontal lines. Inline is available with Princeton frontals (excludes Paint to Order).

INLINE MATT BLACK TRIM



INLINE BRASS TRIM



INLINE GUNMETAL TRIM



INLINE ALUMINUM TRIM



YOUR CONTEMPORARY STYLE

Our contemporary range of kitchens can create a unique distinctive look, from sleek super-matt kitchens that include the latest robust anti-fingerprint surface technology, to Alta high gloss reflective designs that can make a space seem bigger and brighter. Our collection also includes a full paint to order colour palette to pick from as well as the latest trend designs such as elegant Dark Walnut, Riviera Oak and industrial style Concrete & Dark Stone.

Choose from a single range throughout your kitchen, or be adventurous and use a contrasting textured finish. Turin Dark Stone and Charcoal, or Virginia Riviera and Melrose Merlot Red complement each other perfectly.

For an ultra sleek modern design choose a handleless style such as New York with its integrated handle, or our Inline trim handle options.

monochrome style



riviera and charcoal combined to give a stylish design



melrose smooth matt kitchen with inline handles

finishing touches

Create your unique style when selecting handles, work surfaces and wall splashbacks.



for a modern design choose, black, bright brass or textured handles

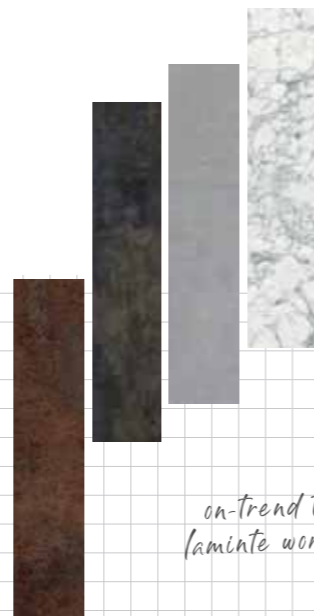

on-trend thin laminate worktops

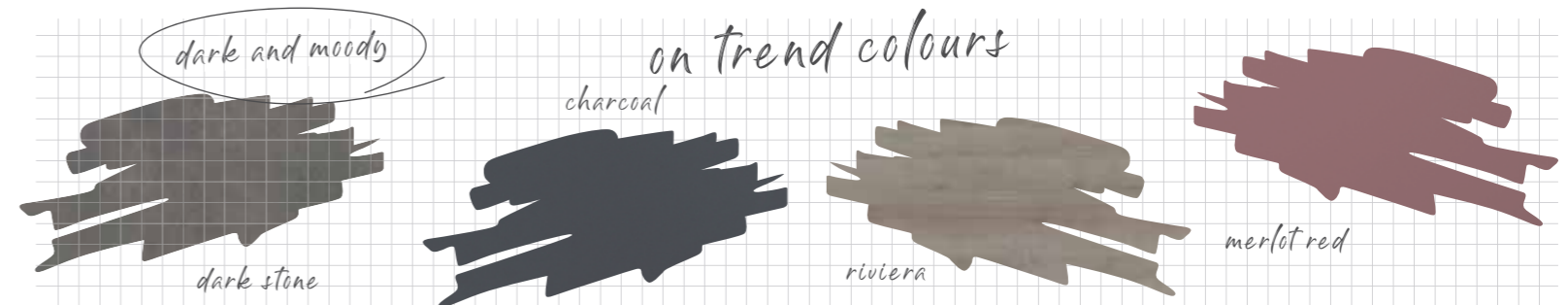

dark and moody

dark stone

charcoal

on trend colours

riviera

merlot red

40

tall wall cabinets offer plenty of stylish storage

new york blender panels allow the handle to flow around the furniture

NEW YORK PAINT TO ORDER

New York is a modern and elegant style featuring an integrated pull handle to the top of each door and drawer. With twenty two paint to order colours to choose from New York Paint to Order is the perfect choice for a contemporary design.

PRICE BAND - 4

elegant handleless design

NEW YORK INDIGO
40MM MARBLE SIROCO WORK SURFACE



42

NEW YORK MATT ANTHRACITE



NEW YORK GLOSS

43



NEW YORK PAINT TO ORDER
MIDNIGHT BLUE

highly reflective style

ALTA

Alta makes for a stunning contemporary kitchen style. Alta is available in three popular gloss colours, one matt option and our full suite of painted colour choices. Alta works well in a two tone kitchen design either mixed with an accent timber or another Alta finish.

ALTA MATT PRICE BAND - 2
ALTA PAINT TO ORDER PRICE BAND 2
ALTA GLOSS PRICE BAND - 3

ALTA GLOSS PURE WHITE
BLANCO ZEUS SILESTONE WORK SURFACE
INLINE MATT BLACK TRIM



46

ALTA DUSTY PINK AND MATT ANTHRACITE



47

ALTA BLACK

Paint to Order
Dusky Pink

Matt Black
Sculptured Handle

blanco zeus silestone

get the look

our cabinets can be used to create more than just your kitchen they can be used to create unique features such as a dedicated coffee area

WOODBURY

Our popular Woodbury range of kitchens is available in four gloss colours; Anthracite, Cashmere, Platinum and White. Accessorise with statement handles or inline trims then add a striking modern worktop to create a bright welcoming kitchen design.

PRICE BAND - 2

WOODBURY ANTHRACITE AND WHITE
40MM PREMIUM WOODSTONE WORK SURFACE
INLINE ALUMINIUM HANDLE

50

matching concrete work surfaces

opulent black metal frames

URBAN

An Urban kitchen represents the latest in on-trend interior design. The industrial look of Concrete creates a designer kitchen to be proud of and is also made from 100% recycled chipboard along with the Urban Grey Walnut finish.

PRICE BAND - 0

embrace your creativity

URBAN CONCRETE
22MM CONCRETE WORK SURFACE
INLINE MATT BLACK TRIM



52



53

marble bianco
work surface

inline brass trim suits
the indigo colour

urban indigo and
white finishes

get the look

URBAN INDIGO AND MATT WHITE
22MM MARBLE BIANCO WORK SURFACE
INLINE BRASS TRIM

BOTTOM RIGHT: URBAN GREY WALNUT (100% RECYCLED CHIPBOARD) AND PEBBLE

TURIN

Turin is the ultimate in modern kitchens. With its two dramatic textured frontals Dark Stone & Dark Walnut and the smooth on-trend options of Charcoal & Hunter Green why not explore your darker side.

PRICE BAND - 0

indulge your creativity

TURIN DARK STONE AND CHARCOAL
20MM MARENGO SILESTONE WORK SURFACE
VINTAGE MATT BLACK & COPPER BAR
HANDLE (HPK727)



56



dark walnut



hunter green

57

marble bianco
work surface

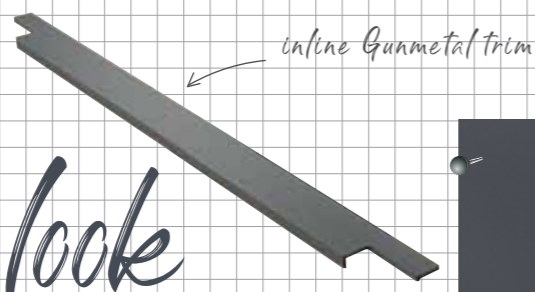

inline Gunmetal trim



Turin Charcoal with
Virginia Riviera accents

get the look

TURIN CHARCOAL & VIRGINIA RIVIERA
SOLID TIMBER OAK WORK SURFACE
GUNMETAL INLINE TRIM

TOP RIGHT: TURIN DARK WALNUT

BOTTOM RIGHT: TURIN HUNTER GREEN

smooth sophisticated design

MELROSE

Melrose with its three smooth colour choices is perfect choice for any contemporary kitchen design. With two muted shades of Mineral & Storm Blue to the deeper darker tone of Merlot Red that really makes a statement.

PRICE BAND - 0

MELROSE MERLOT RED & MINERAL
20MM SILESTONE DESERT SILVER
WORK SURFACE
INLINE GUNMETAL TRIM



60

MELROSE MERLOT RED AND MINERAL



61

MELROSE STORM BLUE

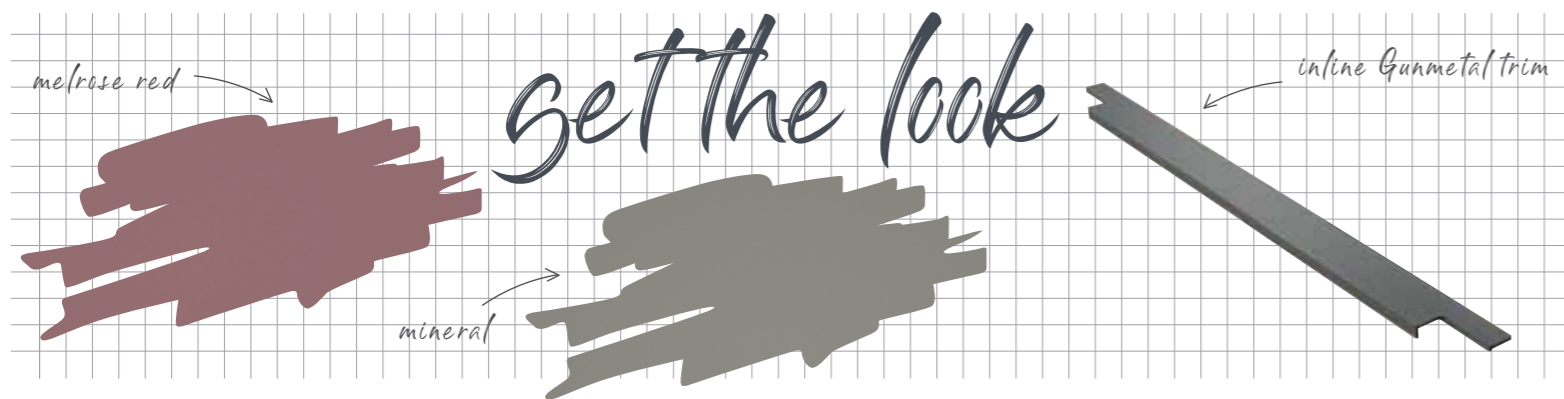

melrose red

mineral

inline Gunmetal trim

get the look

using inline handle trims creates a sleek streamline look especially when used across a full run of base cabinets as shown here

62

hidden canopy extractor

↑
statement matt
black handle

HACIENDA

Hacienda offers a choice of timber effect or smooth matt doors to create the ideal mix and match combination. Plus the Grey Driftwood and Light Driftwood finishes are made from 100% recycled chipboard.

PRICE BAND - 0

an interior design statement

HACIENDA PLATINUM AND GREY DRIFTWOOD
(100% RECYCLED CHIPBOARD)
40MM ARCTIC MARBLE WORK SURFACE
MATT BLACK KNURLED BAR HANDLE (HPK809)



PLAZA

Create a calm relaxing tone to your kitchen by selecting the subtly textured Plaza range. These painted effect finishes are available in three beautiful colours; Cashmere, Cobble Grey and Porcelain.

PRICE BAND - 0

PLAZA CASHMERE
22MM ANTIQUE BRONZE WORK SURFACE
INLINE ALUMINIUM HANDLE

VIRGINIA

Virginia Riviera is a simple, yet elegant finish that fuses the essence of sophistication with contemporary design especially when mixed with a darker frontal such as Turin Charcoal (as shown). Virginia is also available in a Blonde Oak finish.

PRICE BAND - 0

warm hearty design

VIRGINIA RIVIERA AND TURIN CHARCOAL
20MM CORKTOWN SILESTONE QUARTZ
WORK SURFACE
BARRINGTON BLACK BAR HANDLE - HPK877

CONTEMPORARY DOOR SUITE

Now you have seen the selection of kitchen styles we offer it's time to shortlist your favourites. Do you want a single colour kitchen or will you mix and match different decors?

PAINT TO ORDER DOOR STYLES



Alta



New York

PAINT TO ORDER COLOURS



CONTEMPORARY

NEW YORK GLOSS			NEW YORK MATT	ALTA GLOSS			ALTA MATT	
Gloss Dusk Grey	Gloss Pearl Grey	Gloss White	Matt Anthracite	Gloss Dusk Grey	Gloss Pearl Grey	Gloss Pure White	Alta Glazed	Matt Anthracite
WOODBURY				TURIN				
Gloss Anthracite	Gloss Cashmere	Gloss Platinum	Gloss White	Charcoal*	Dark Stone	Dark Walnut	Hunter Green	
MELROSE			URBAN					
Merlot Red	Mineral	Storm Blue	Cobble Grey*	Concrete	Grey Walnut	Indigo*	Pebble*	White*
VIRGINIA		PLAZA						
Blonde Oak	Riviera	Cashmere	Cobble Grey	Porcelain				
HACIENDA								
Grey Driftwood	Light Driftwood	Nordic Blue	Platinum	Black Aluminium Frame, Tinted Glass				

← feature glazed door

Door and draw fronts in this range are made using rPET foil made from recycled plastic bottles

Door and drawer fronts in this range are made using a % recycled chipboard.

Our paint to order ranges are available in any of the 22 paints shown, whilst all the available colours of our general kitchen ranges are shown above. Then browse the handle and work surface pages to collate your preferred style.



CONTEMPORARY HANDLES

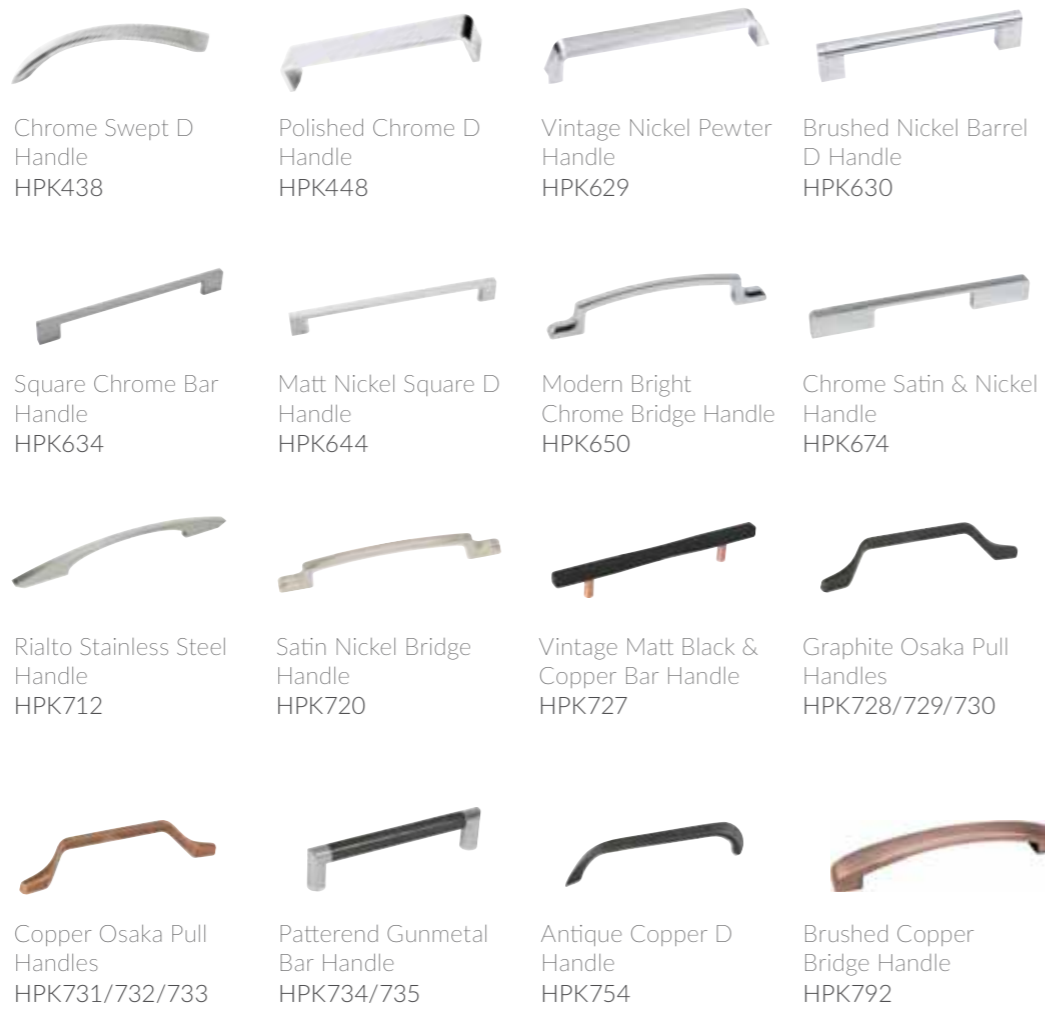

Our choice of contemporary handle options add style and design flair to your kitchen design. Choose a subtle shape or a more flamboyant design to suite your unique style.

INLINE TRIMS

Our Inline trims offer a contemporary sleek style kitchen design that creates a handleless look and accentuates clean flowing horizontal lines. Inline is available on all of our contemporary kitchen designs (except for New York and Alta Paint to Order). Inline is available in the four trim finishes shown here.



LINEAR HANDLELESS

They're rational. They're functional. They're very beautiful. And their flexibility helps you bring pin sharp contemporary design to any environment. Inspired by uncluttered modernism, we've created a range of styles that complement anything from a new-build apartment to a refurbished mill. Lines are clean and satisfying. Tones are subtle and muted. Doors and drawers are handleless.

These are kitchens that look at home in any space. We've built enormous flexibility into all our ranges. If you want tall, wide, fitted or island units, you'll find our kitchens can flex to fit your imagination.

Linear offers a varied range of finishes to help you make the most of these subtleties. You can master the art of understatement with a

variety of matt designs featuring touchable textures across a variety of wood grains and colours. Or you can select from a palette of gloss designs in a spectrum of subtle shades. Whatever you choose, it will retain a soft, restrained tone that focuses attention on the sleek, simplified forms of our kitchens' minimal, modern designs.



icon smooth matt merlot red and storm blue

modern style pantry cabinet



finishing touches

Create your unique style when selecting trims, work surfaces and wall splashbacks.

trim finishes



aluminium



brass



copper



bronze



matt black

statement colours
black green and red



painted black



hunter green

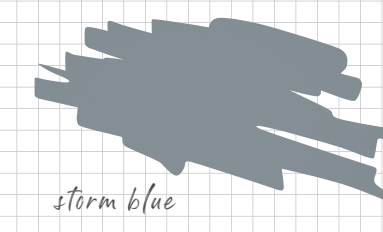

storm blue

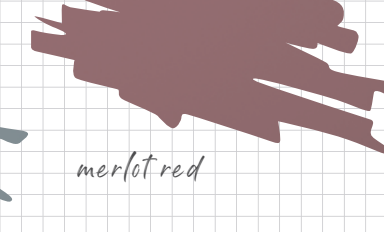

merlot red

on trend colours



74

MATT PAINTED CLAY AND
STONE WITH BRONZE TRIM

LINEAR AVANT

75

SLEEK SURFACES AND DELICATE DETAIL

Handleless kitchens provide a more
pared-back, streamlined look and Linear
Avant is no exception.

LINEAR TREND

SUBTLE TONES & SMOOTH STYLING

The smooth and gloss finishes create a stunning subtle style that fits perfectly with the modern, handle-less style of Linear Trend.

MATT ANTHRACITE AND GLOSS PEARL
GREY WITH MATT BLACK TRIM





MATT CHARCOAL WITH
MATT BLACK TRIM

LINEAR FINESSE

CONTEMPORARY MEETS TRADITIONAL STYLE

Linear Finesse combines the ultra modern simplicity of handleless design with the traditional feel of a shaker.



DARK STONE WITH
GUNMETAL TRIM

LINEAR ICON

NATURE INSPIRED
ICONIC STYLE

Create an iconic natural inspired look and feel in your kitchen space, with a mix of material textures and colour tones.



DARK WALNUT WITH
MATT BLACK TRIM



GLOSS PLATINUM WITH
MATT BLACK TRIM

LINEAR ICE

CONTEMPORARY MEETS
TRADITIONAL STYLE

Linear's Ice gloss doors are perfect for creating light and space. With its sleek, sophisticated finish this range creates a bold statement.



86

87

LINEAR FORM

INDUSTRIAL SHEEK

Create an stunning industrial style kitchen with Linear Form Concrete and combine with a timber work surface for a welcoming feel.

CONCRETE WITH MATT
BLACK TRIM



DOOR FINISHES

We've selected a wide range of finishes to perfectly complement the sleek lines of our kitchens. They give you everything you need to accentuate shapes and make the most of the kitchen space.

ICE

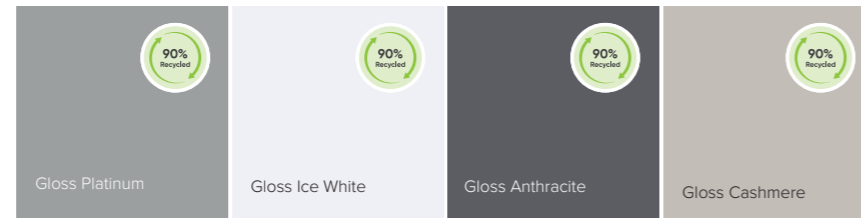

AVANT



TREND

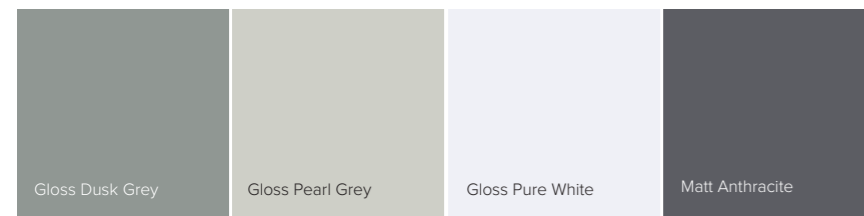

FINESSE

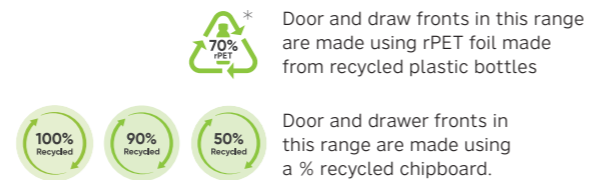
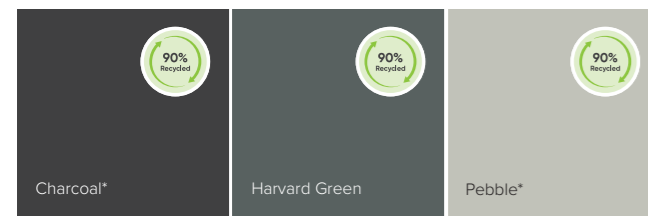

ICON

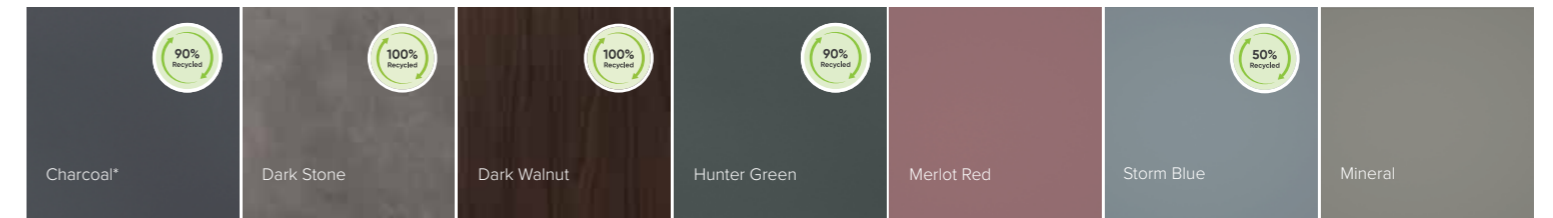

FORM

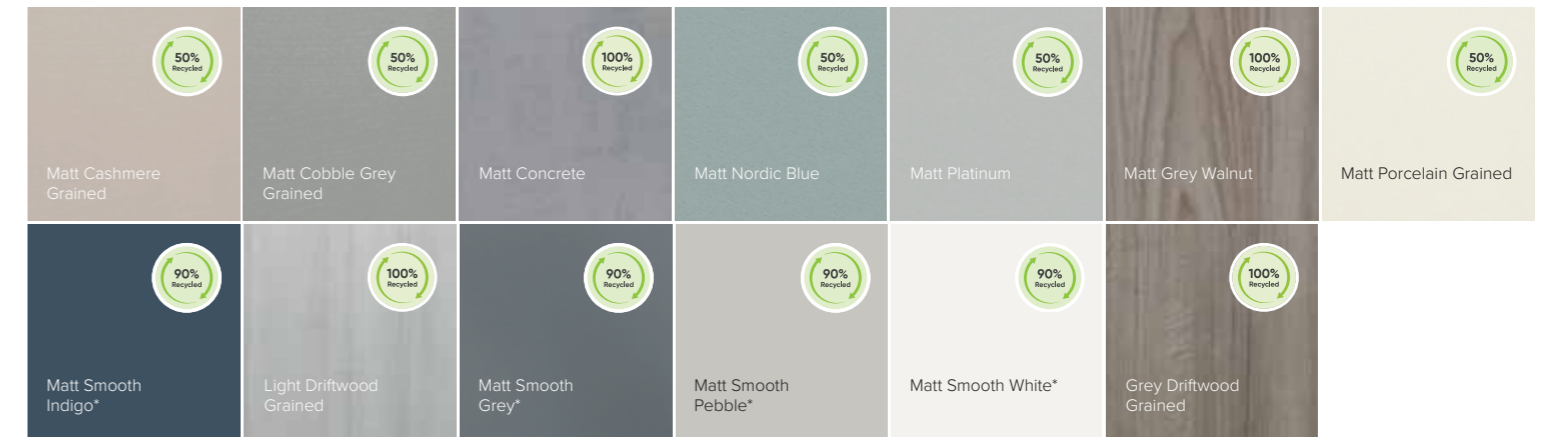

TRIM FINISHES

The main piece of a handle-less kitchen is the trim. A stunning touch that provides an accent to contrast with, or compliment, the overall kitchen finish.

Choose from five distinctive finishes which provide your new kitchen with a touch of flair and personalisation.

Matt Black

Aluminium

Bronze

Brass

Copper

Be Inspired



*add your
own style*



FINISHING TOUCHES

You've chosen the style, you've decided the finish, now it's time to choose the finishing touches that make a new kitchen truly your own. Handles, lighting and storage accessories are the essential extras that not only enhance the beauty of your new furniture but also make it perfectly practical.

92



*it's all in
the detail*



WORK SURFACES

The work surface is a key element in the appeal of the final kitchen design. Choose a subtle decor to complement your kitchen choice, or select a statement decor that will become the star of your design. Durable with easy-clean technology, our range of work surfaces offer individuality in your kitchen.

All our laminate worktops are FIRA Gold certified and are made using FSC® chain of custody certified chipboard.



matches our urban concrete kitchen

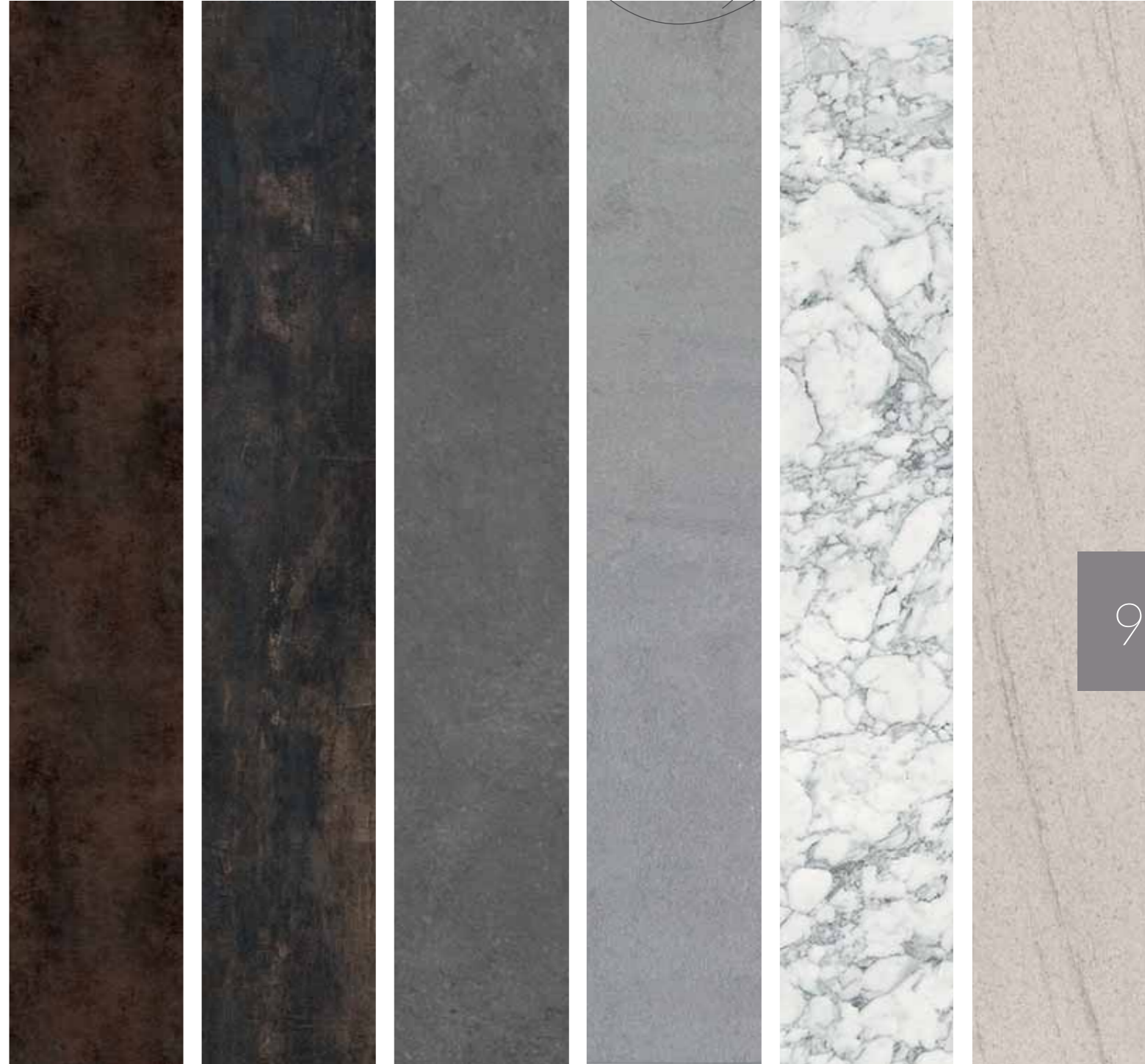

Antique Bronze Antique Steel Brazillia Concrete Marble Bianco Pearl Granite

LAMINATE WORKTOP PROFILE OPTIONS



22MM PVC-EDGED LAMINATE WORKTOPS

These stunning 22mm worktops feature subtle textured surfaces and are the cutting edge of laminate worktop design.





Alaska Alpine White Brazilian Walnut Carbon Steel Conway Elm Copper Slate Dark Ash Everest Black



Arctic Marble Chalet Oak Cinnamon Cloudy Cement Colmar Oak Grey Terrazzo Liberty Rock Silver Oak



Marble Siroco Oak Block Pastel Oak Tectonica



Venice Marble Volcanic Ash Woodstone



arctic marble

40MM POSTFORMED & PVC-EDGED LAMINATE WORKTOPS

Our 40mm worktops are supplied in a postformed or PVC-edged specification and are available with co-ordinating upstands and splashbacks.

40MM PREMIUM LAMINATE WORKTOPS

Our range of premium worktops feature enhanced textures whether that be a woodgrain effect or a smooth marble finish. They feature a tighter radius of 3mm for a more contemporary square edged look and feel.



Cascade

Lucido

Neve

Onda

Savanna

neve ↙



34MM EARTHSTONE WORKTOPS

Earthstone is a great affordable alternative to solid surface worktops such as quartz or granite. Available in 5 colours, Earthstone has been designed to give a smooth surface appearance while being easy to clean and maintain.

Earthstone worktops feature a 6mm solid surface on a chipboard core and are finished with a 45° chamfer to the top and base. They are available with matching worktop hob splashbacks and upstands to complete the look.



standard collection ↗

↖ *glass collection*



GLASS SPLASHBACKS

Glass is such a wonderfully versatile material.

Our glass splashbacks and upstands are a great alternative to tiles, but their appeal goes far beyond the practical: they also make a centrepiece for the entire kitchen.

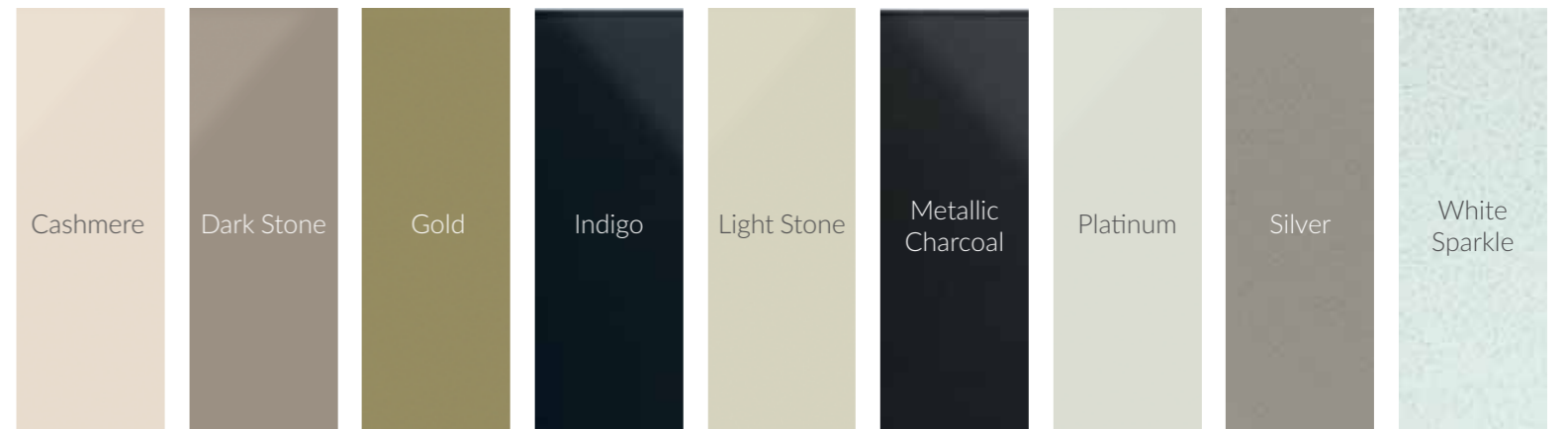



silver drawers shown

silver pan drawers with glass sides shown



DRAWER SOLUTIONS



Modular Metal Cutlery Tray for Atira Drawer Box



Full Width Plastic Cutlery Tray for Atira Drawer Box



Aluminium Pan Drawer Organisers for Atira Drawer Box



Modular Timber Deep Pan Drawer Organiser for Atira Drawer Box

Take advantage of every space with a range of innovative drawer options from cutlery trays to drawer organisers for our anthracite and silver Atira drawers.

anthracite drawer



Modular Timber Cutlery Tray for Atira Drawer Box

natural wood storage system



Modular Timber Deep Pan Drawer Organisers for Atira Drawer Box
(Anthracite drawer shown with two organisers)



Timber Plate Stack for Atira Drawer Box
(Anthracite drawer shown)

CUTLERY TRAYS

A cutlery tray is a must for a well organised kitchen. Choose our full width plastic moulded design, or our modular metal or timber organisers which can be positioned as required.

PAN DRAWER ORGANISERS

Deep pan drawers provide great access to cabinet contents and can be easily arranged with our organisers.

* see below for module code



Roll Dispenser & Timber Cutlery Tray for Atira Drawer Box
(Silver drawer shown)



Timber Knife Block & Cutlery Tray for Atira Drawer Box
(Anthracite drawer shown)



Timber Knife Block & x2 Cutlery Trays for Atira Drawer Box
(Silver drawer shown)



Spice Rack, Slideable Tray & Roll Dispenser for Atira Drawer Box
(Silver drawer shown)



DRWTACC1



DRWTACC2



DRWTACC7



DRWTACC8



DRWTACC9



DRWTACC3



DRWTACC4



DRWTACC10



DRWTACC11



DRWTACC5



DRWTACC6



DRWTACC12



DRWTACC13

fsc sustainably sourced wood

102



Timber Spice Rack & Cutlery Tray for Atira Drawer Box
(Anthracite drawer shown)



Timber Knife Block, Cutlery Tray & Roll Dispenser for Atira Drawer Box
(Silver drawer shown)

103

TIMBER DRAWER ACCESSORY MODULES

Our timber drawer internals offer excellent storage solutions for cutlery drawers. With a selection of storage options such as knife blocks, spice racks and roll dispensers, drawers can be accessorised to suit your individual requirements.



ORDERING TIMBER DRAWER MODULES

We have an assortment of timber modules for Atira metal drawers. The arrangements shown are available using the codes displayed here for ease of ordering.

Please speak to your kitchen designer for more drawer storage options.



* DRWTACC14

500 & 600mm Anthracite Cranked Pull Out



400, 450, 500 & 600mm Anthracite Le Mans Corner Unit Storage



150 & 300mm Chrome Base Unit Pull Out



150 & 300mm Anthracite Base Unit Pull Out



150mm Chrome Towel Rail Pull Out



3/4 Chrome Carouse



400, 450, 500 & 600mm Chrome Le Mans Corner Unit Storage



300mm Anthracite Larder Unit Pull Out



500 & 600mm Chrome Cranked Pull Out



300, 400 & 500mm Chrome Larder Unit Pull Out

PREMIUM STORAGE SOLUTIONS

Our premium storage solutions from Kesseböhmer provide easy convenient access to cabinet contents. Make the most of corner cabinet, tall larder cabinets and wall cabinets with pull out storage. Our premium storage brings a stylish designer touch with either a polished chrome or matt anthracite finish as detailed here.



IMove Pull Down Basket - (for 724mm and 900mm high single door Premium specification wall cabinets only)



600mm Premium Bin



600mm Recycling Bin



300mm Premium Bin



400mm Under Sink Bin



LIGHTING & ACCESSORIES



Expanse Pro Light Panel
Switch between cool, Neutral or warm.



Loox aluminium profile with LED
light strip.



Nexus Slim Triangle Under
Cabinet Light



TrioTone Circular Light
Switch between cool, neutral or
warm white light.



Astro TrioTone Light
Switch between cool, neutral or warm
white light.
Available in Black, Brass and Silver

The importance of lighting can not be underestimated, it is a crucial element to any kitchen. Lighting can make your kitchen look warm and welcoming or cool and fresh. With our selection of low energy LED lighting you can add the perfect finishing touch to set your kitchen apart.



Pop up socket with
premium stainless-steel
finish 3 sockets
1 x USB-A port
1 x USB-C port



Pop up socket with USB
3 sockets
2 x USB-A ports



Motorised pop up socket
with built in Bluetooth
audio speaker and
stainless-steel lid and
USBs 3 sockets
2 x USB-A ports



In-Cabinet Strip Light



Glow Glass Shelf Light.
Cool lights.



LED Ion8 strip lights.
Adjust between cool,
neutral or warm white light



LED Square Plinth Lights



*illuminated wall
cabinets*



Flip socket in a concrete effect ceramic finish with
2 x sockets and 1 x USB-A port



Flip socket in a stainless steel finish with 2 x sockets and
1 x USB-A port.

STANDARD WALL CABINET SPECIFICATION

Our 18mm Standard Cabinet is robust, practical, fully FIRA Gold certified and available in three colours along with our suite of replacement cabinet end panels to create a co-ordinated look. Drawers are available in anthracite, silver or an upgrade oak finish.



Fig. A Fig. B Fig. C



Fig. D Fig. E Fig. F



Fig. G Fig. H Fig. I

IN-FRAME CABINET

A few features of an In-Frame New England cabinet vary as detailed below:

2 wall unit heights (724mm and 900mm only)

A special width drawer box to allow for the frame (see Fig. I)

A special designed 3-way fully adjustable soft close clip on hinge (see Fig. H)

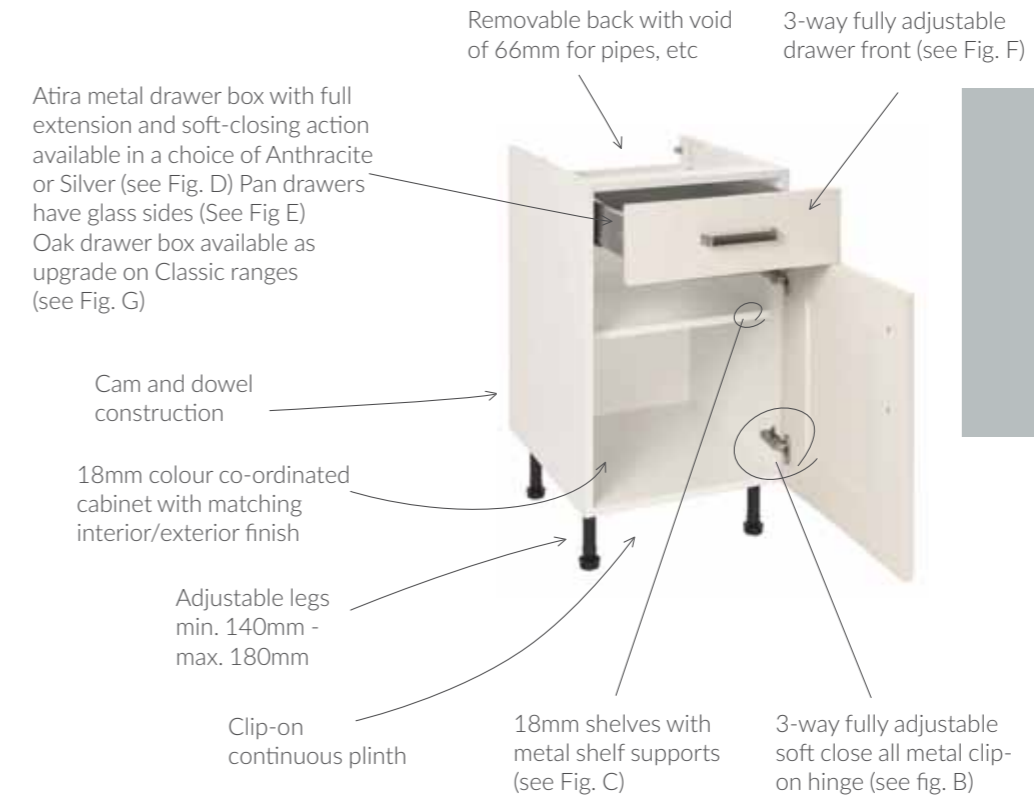

STANDARD BASE CABINET SPECIFICATION

CABINET COLOUR OPTIONS

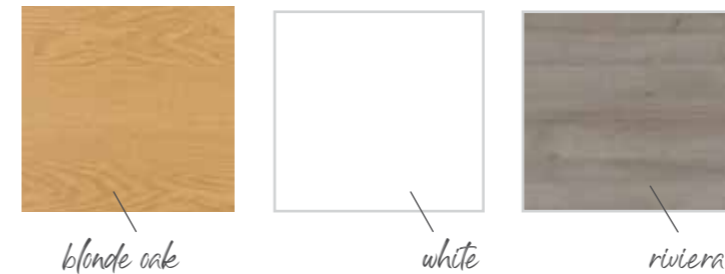

REPLACEMENT CABINET ENDS

A selection of our ranges are available with frontal matched replacement cabinet ends. This provides a variety of cabinet options allowing you to create a fully co-ordinated kitchen. Please speak with your designer for further information.



PREMIUM WALL CABINET SPECIFICATION

3 wall unit heights (561mm, 724mm & 900mm)

18mm colour co-ordinated cabinet with matching interior/exterior finish. Available with a choice of Cashmere, Graphite, Light Grey & Mid Grey cabinet edging as an optional cabinet edging choice

PVC edging to all front cabinet and shelf edges

Concealed fully adjustable wall hanging bracket (see fig. A)

Metal shelf supports (see fig. C)

18mm shelves, Glazed units include glass shelves as standard

8mm one piece solid back panel



330mm deep cabinet

Cam and dowel construction

3-way fully adjustable soft close all metal clip-on hinge (see fig. B)

Our Premium Cabinet includes a number of upgrade features including;

Additional grey linen cabinet colour

Deeper wall cabinets (330mm to suit dinner plates)

PVC protected front edges to the cabinet

A choice of PVC edging colours

Co-ordinated edging colours on centre uprights in double cabinets

Reduced drill holes inside cabinets

Solid back panels



Fig. A



Fig. B



Fig. C



Fig. D

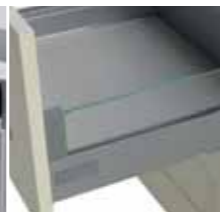

Fig. E



Fig. F



Fig. G



Fig. H



Fig. I

IN-FRAME CABINET

A few features of an In-Frame New England cabinet vary as detailed below:

2 wall unit heights (724mm and 900mm only)

A special width drawer box to allow for the frame (see Fig. I)

A special designed 3-way fully adjustable soft close clip on hinge (see Fig. H)

Atira metal drawer box with full extension and soft-closing action, available in a choice of Anthracite or Silver (see Fig. D) Pan drawers have glass sides * (See Fig E) *Oak drawer box available as upgrade on Classic ranges (see Fig. G)

Cam and dowel construction

18mm colour co-ordinated cabinet with matching interior/exterior finish. Available with a choice of Cashmere, Graphite, Light Grey & Mid Grey cabinet edging as an optional cabinet edging choice

Adjustable legs min. 140mm - max. 180mm

Clip-on continuous plinth

Removable 15mm solid back with void of 66mm for pipes, etc

3-way fully adjustable drawer front (see Fig. F)



18mm shelves with metal shelf supports (see Fig. C)

3-way fully adjustable soft close all metal clip-on hinge (see fig. B)

PREMIUM BASE CABINET SPECIFICATION

CABINET EDGING COLOURS

Premium cabinets are available with either matching PVC front edges, or in a colour to co-ordinate or contrast with the frontal. These four additional edging colour choices are available;



Graphite (edging colour only)



Cashmere (edging colour only)



Light Grey (edging colour only)



Mid Grey (edging colour only)

CABINET COLOUR OPTIONS



blonde oak

grey linen

white

riviera

REPLACEMENT CABINET ENDS

A selection of our ranges are available with frontal matched replacement cabinet ends. This provides a variety of cabinet options allowing you to create a fully co-ordinated kitchen.

Please speak with your designer for further information.



white cabinet with glass dusk grey replacement ends shown



LINEAR HANDLELESS WALL CABINET SPECIFICATION

The Linear product specification includes 18mm cabinets supplied with solid backs, a choice of cabinet matched matt aluminium, matt black or matt white PVC or ABS cabinet edging and soft-close hinges/drawers as standard. Wall cabinets are 330mm deep to maximise storage space and are supplied with an aluminium integrated and concealed handle trim.

Base cabinets are notched to accept the trim and are available either in a full height or with soft-close drawers.

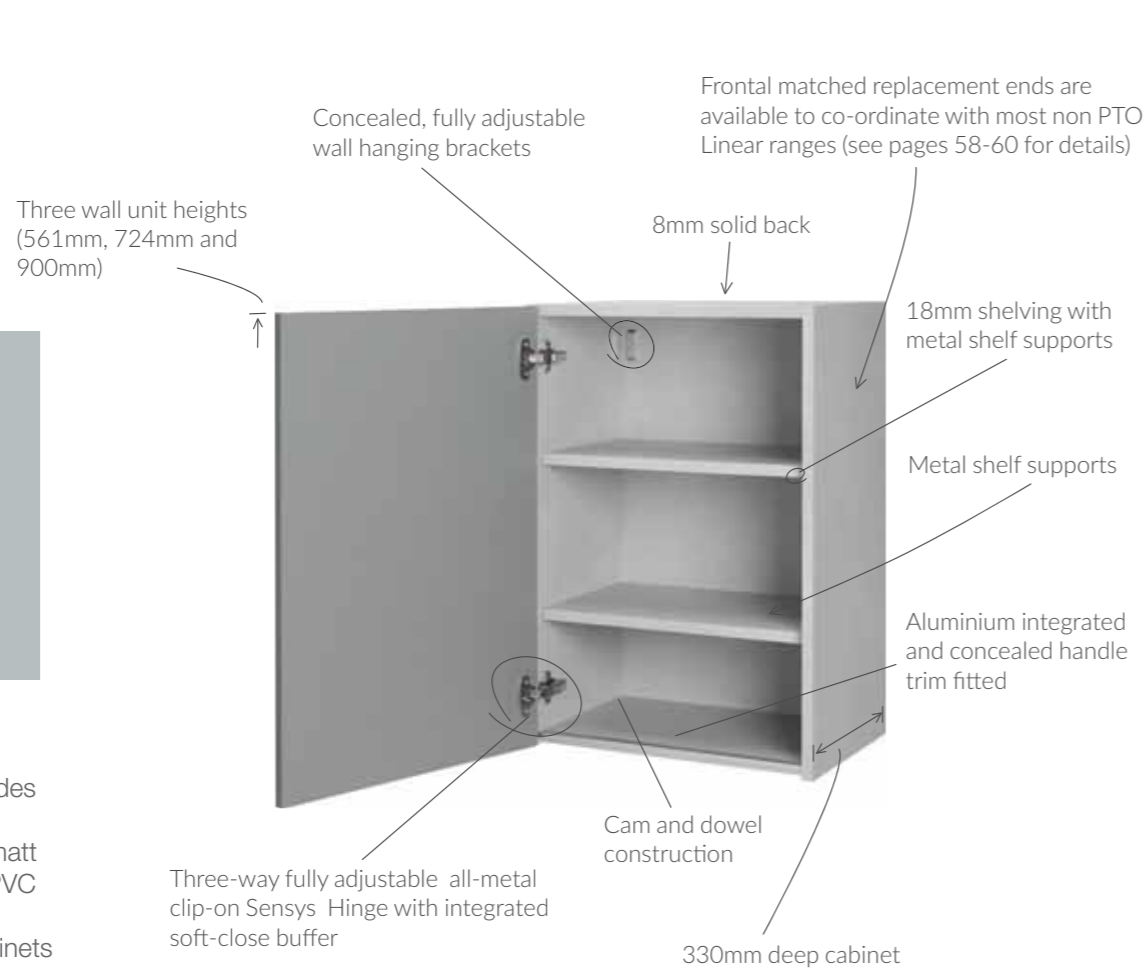

CABINET COLOUR



CONTRASTING EDGING COLOURS

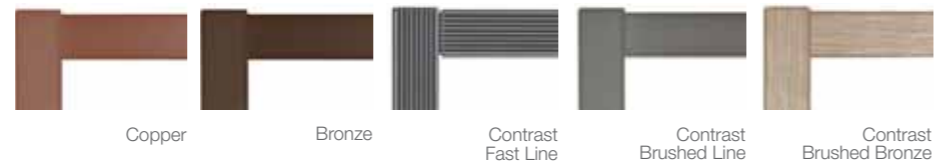

TRIM FINISHES

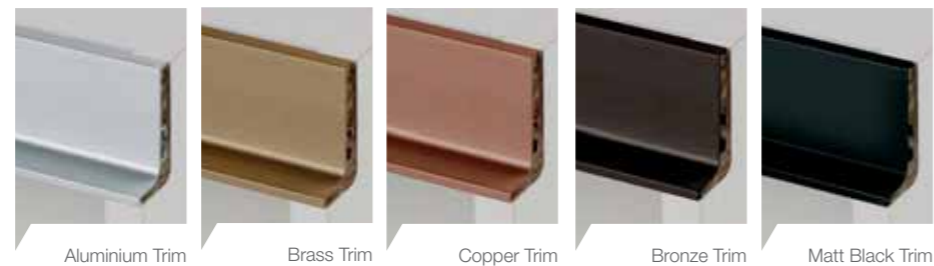

LINEAR HANDLELESS BASE CABINET SPECIFICATION

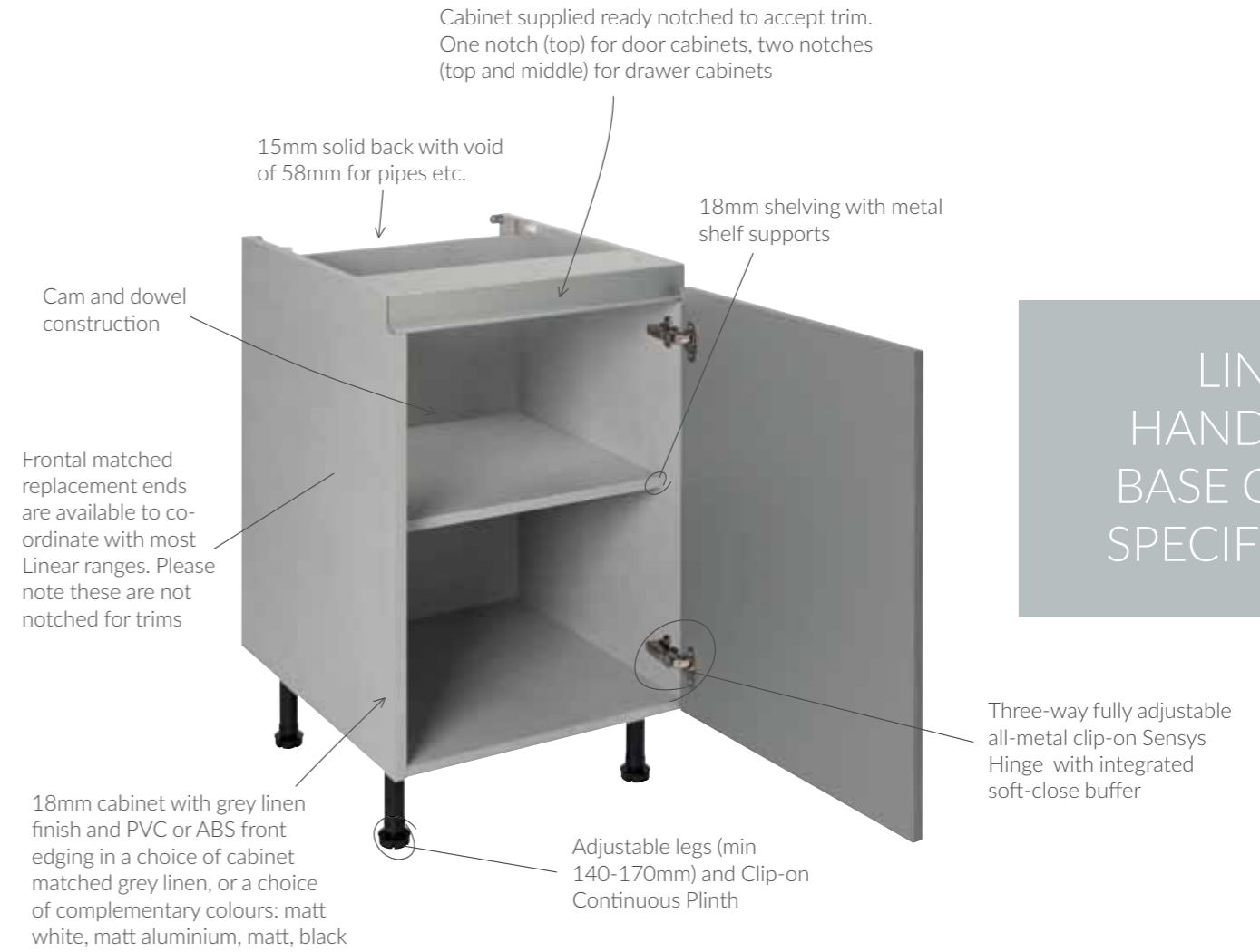

FEATURES

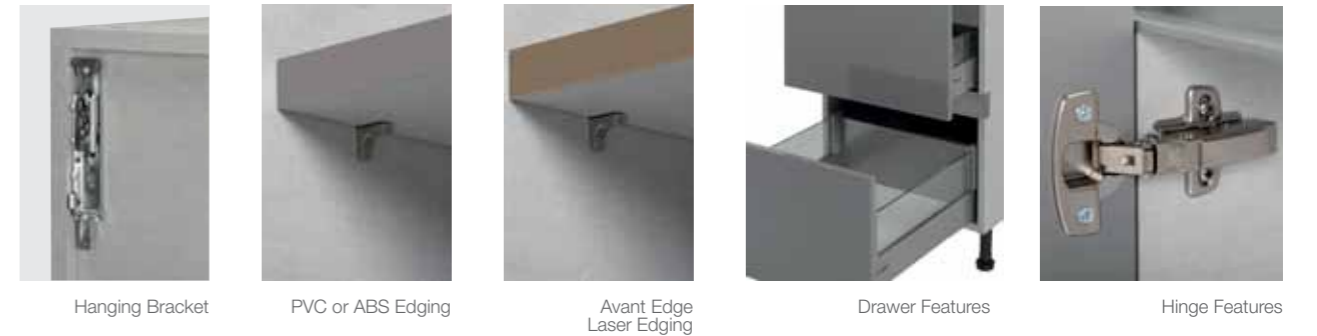

Metal-sided Atira drawer box with full extension and soft-closing action. Three-way fully adjustable drawer front. Pan drawers have glass sides as standard. Drawer Boxes are available in either Silver or Anthracite. Push to open internal drawers.

Sensys is the latest generation in hinge technology. The soft-close element is integrated invisibly into the hinge – an innovation that meets the highest criteria for convenience and functionality. Just a light touch and the door closes smoothly and silently.

sirius
Buying Group

We've a bunch of
hand-picked retailers

www.siriusbuyinggroup.co.uk



Symphony[®]

